

Version 1

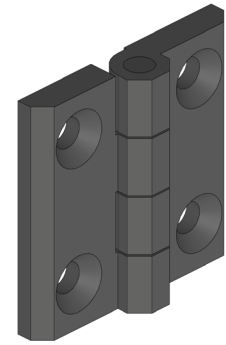

Countersunk holes on both sides.

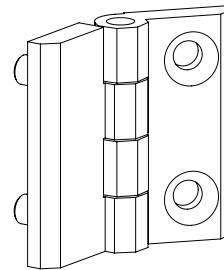
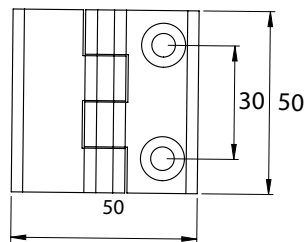
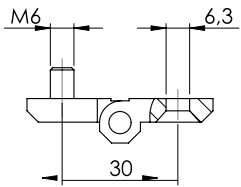

Version 2

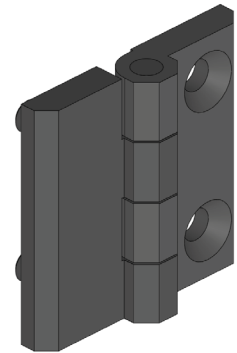

Countersunk holes on one side and threaded studs on the other side.

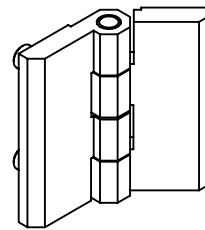
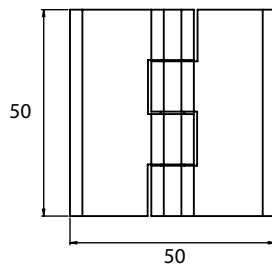
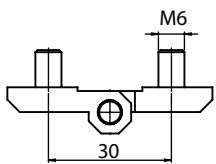

Version 3

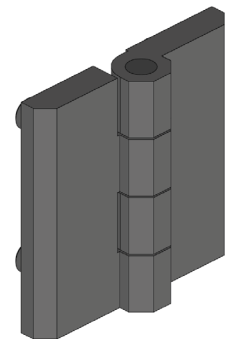

Threaded studs on both sides.

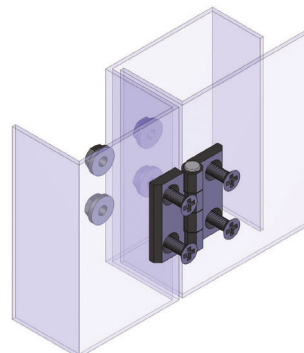

Material	Version	Code	Code
		Chrome	Black painted
Zamak, steel pin	1	332-V1-1-1	332-V1-1-5
	2	332-V2-1-1	332-V2-1-5
	3	332-V3-1-1	332-V3-1-5
Polyamide black, steel pin	1	N/A	332-V1-2-5
	2	N/A	332-V2-2-5
	3	N/A	332-V3-2-5

* All dimensions are in mm